

Outdoor Furniture

1-Year Limited Warranty Program

For a period of one (1) year after date of purchase, the Manufacturer will either repair or replace defective components in accordance with this Limited Warranty. This warranty is between the Manufacturer and the original purchaser and is valid only when accompanied by the original purchaser's sales receipt showing original date of purchase and location of purchase. Replacements under this warranty revert back to the date of original purchase for future warranty.

The Manufacturer or its authorized dealer can accept or reject warranty claims based on its findings. This warranty applies in normal residential use only and is not intended for commercial use. The Manufacturer can make substitutions as required of materials, components, and sub-components of comparable value and utility. This warranty is limited to product repair or replacement (to be determined solely by the Manufacturer). Warranty return is limited to only the single affected component.

This limited warranty covers only manufacturing defects and does not cover normal wear and tear, damage due to acts of nature (such as, but not limited to freezing or high winds), abuse or misuse, including chemical damage from suntan oil or other chemicals, exposure to extreme heat or cold, abrasion or excessive weight. This product is intended to be used in standard installations only. This warranty is void if the product is not used for its intended purpose. The Manufacturer disclaims liability for any aspect of installation and any inconvenience caused by a defective part of a component.

Certain items are not covered by this warranty. These include, but are not limited to the following:

1. Components subjected to abuse, including abuse intended to simulate failure.
2. Damages caused by retailer, shipper or installation crew (such as scratches, dents, tears, chips, etc.).
3. Any part which merely exhibits normal wear yet functions essentially as new, including chips, scratches or stretching of materials and stitching.
4. Tears, punctures, scratches or any damage caused by improper installation or use.
5. Damage to frames/welds resulting from improper assembly or exposure to water and/or sub-freezing temperatures is not covered. General frame rusting is not covered.
6. Fading and/or discoloration of fabrics/cushions/straps/wicker resulting from exposure to the elements, chemicals, oils, fluids or any other cause are not covered.
7. Umbrella bases are not covered under any circumstances.
8. Items sold "as is" or floor models.

To make a claim, call the toll-free number below. Please have available a copy of the original sales receipt along with a brief description of the problem. Please also provide your email address and daytime telephone or cell phone number. All items may be charged actual freight costs plus \$15 for handling. Repairs or replacement will be made at the Manufacturer's option. ***Sales and use taxes, plus shipping and handling charges are the responsibility of the consumer.***

THIS IS THE ENTIRE EXCLUSIVE EXPRESS LIMITED LIABILITY. THE MANUFACTURER NEITHER MAKES NOR IS RESPONSIBLE FOR ANY OTHER WARRANTIES, EITHER EXPRESS OR IMPLIED, INCLUDING THOSE OF RETAILING DEALERS. THIS EXCLUSIVE REMEDY IS LIMITED TO RECEIPT OF A CREDIT IN CONNECTION WITH THE REPAIR OR REPLACEMENT OF ANY PRODUCT OR COMPONENT DEEMED TO BE DEFECTIVE UNDER THE TERMS AND CONDITIONS AS STATED IN THIS WARRANTY. NEITHER THE PRODUCT MANUFACTURER NOR ITS AGENTS SHALL BE LIABLE IN ANY CASE FOR INCIDENTAL, INDIRECT, SPECIAL OR CONSEQUENTIAL DAMAGES RESULTING FROM THE USE OF THIS PRODUCT OR ARISING OUT OF ANY BREACH OF THIS WARRANTY OR NEGLIGENCE EVEN IF IT HAS BEEN ADVISED OF THE POSSIBILITY OF SUCH DAMAGES. EXCEPT AS OTHERWISE MAY BE REQUIRED BY LAW, THERE ARE NO OTHER EXPRESS OR IMPLIED WARRANTIES OTHER THAN THE WARRANTY DESCRIBED HEREIN, AND ALL OTHER WARRANTIES, INCLUDING ANY IMPLIED WARRANTY OF MERCHANTABILITY OR FITNESS FOR A PARTICULAR PURPOSE ARE EXPRESSLY DISCLAIMED.

Contact Customer Service at 1-866-988-3300

Assembly Instructions

FRSS0837ST

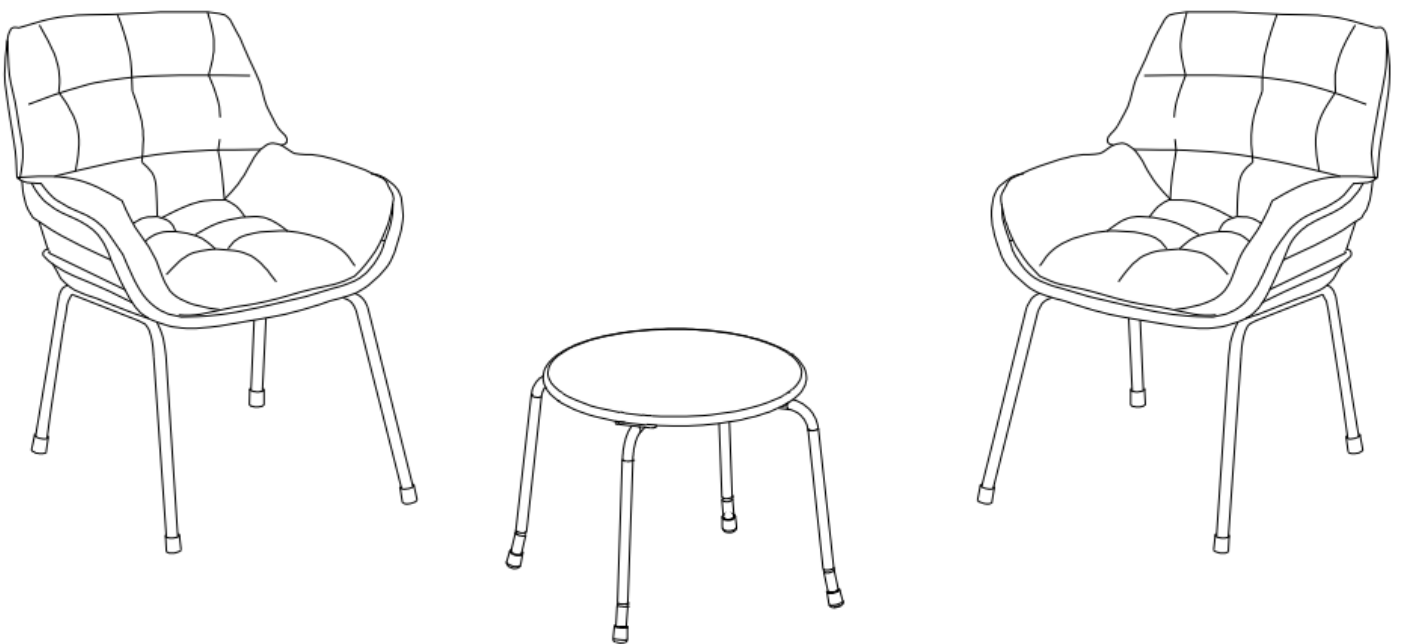









3pc Seating Set

Questions, problems, or missing parts?
Before returning to the store, call Customer Service.

1-866-988-3300
8 a.m. - 5 p.m., PST Monday - Friday

Retain this manual for future use.

Chair Parts & Tools

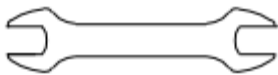
PART	QTY	PICTURE & DESCRIPTION	PART	QTY	PICTURE & DESCRIPTION
A	2	 Chair Frame	C	4	 M6X25 Bolt
B	2	 base	D	4	 M6 Nut
I	2	 Cushion	E	4	 M6 Flat Washer
			F	4	 M6 Plastic Washer
			G	1	 Allen Wrench
			H	1	 Hex Wrench
			<p>WARNING: To avoid damaging this product, assemble it on a soft, non-abrasive surface such as carpet or cardboard.</p>		

Chair Assembly

Step 1:

- Place the chair frame (A) on a soft surface. Line up the bolt holes on the chair frame (A) and Base (B). Put M6 plastic washer (F) in the middle of two tabs, then insert M6x25 bolt (C) through two tabs, M6 plastic washer (F), M6 flat washer (E), M6 nut (D). Tighten using the Allen wrench (G) and hex wrench (H).

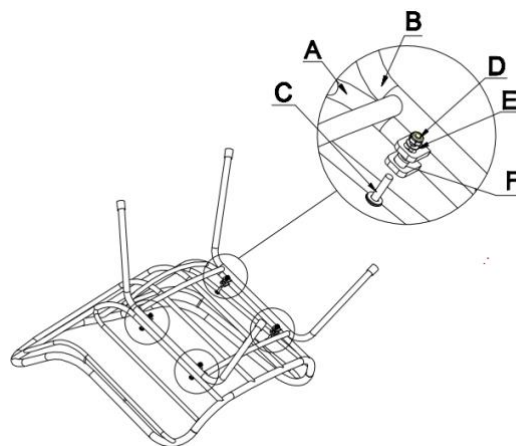

Step 2:

- Ensure all connections are secure.
- Turn the chair right side up.
- Place cushion (I) on the chair as shown.

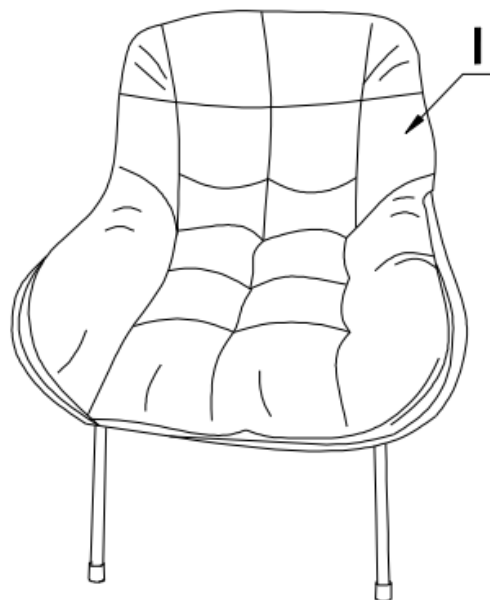

T

Table Parts & Tools







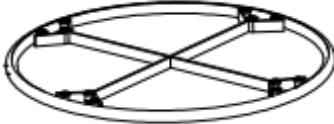

PART	QTY	PICTURE & DESCRIPTION	PART	QTY	PICTURE & DESCRIPTION
A	1	 Table Top	C	4	 M6X32 Bolt
B	4	 Table Leg	D	8	 M6X15 Bolt
			E	12	 M6 Flat washer
			F	12	 Cap
			G	1	 Allen Wrench
			H	4	 Leg Cap
<p>WARNING: To avoid damaging this product, assemble it on a soft, non-abrasive surface such as carpet or cardboard.</p>					

Table Assembly

Step 1:

- Place the table top (A) on a soft surface. Insert the table legs (B) to table top (A) as shown. Insert M6X15 Bolt (D) through Flat washer (E), insert M6X32 Bolt (C) through Flat washer (E), tighten using Allen Wrench (G). Add cap (F) to each screw. Repeat for the other three legs (B).
- Add leg cap (H).

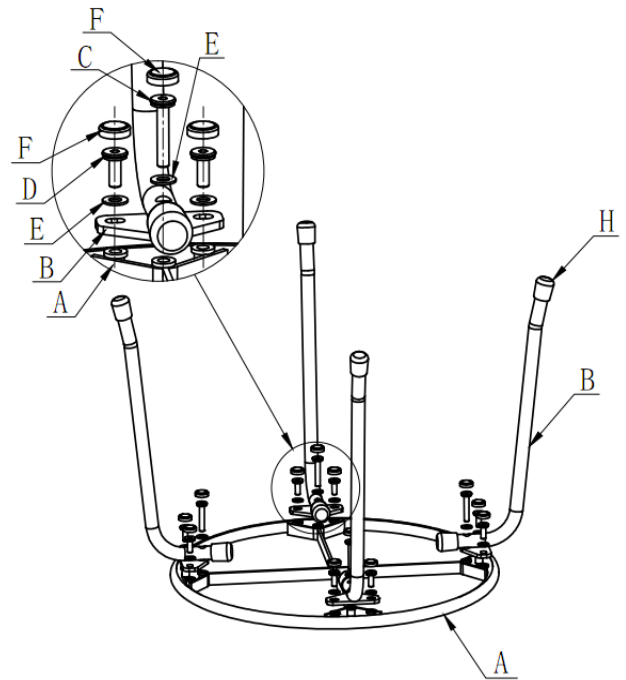

Step 2:

- Ensure all connections are secure.
- Turn the table right side up.

